

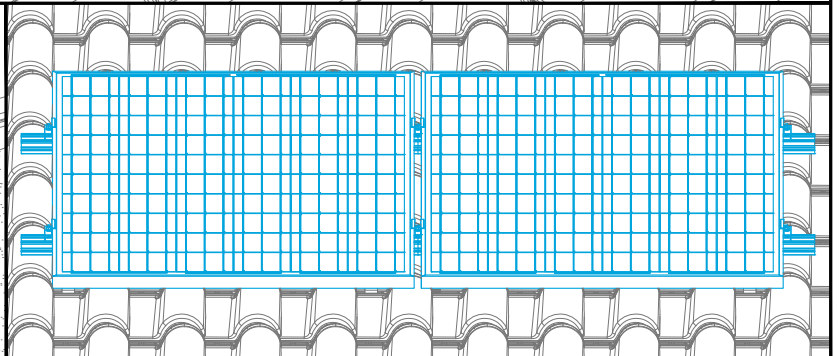

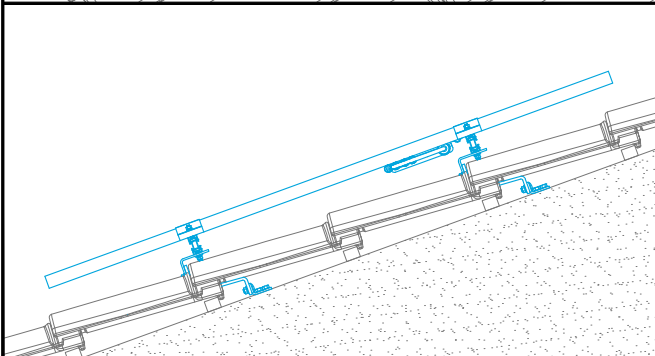

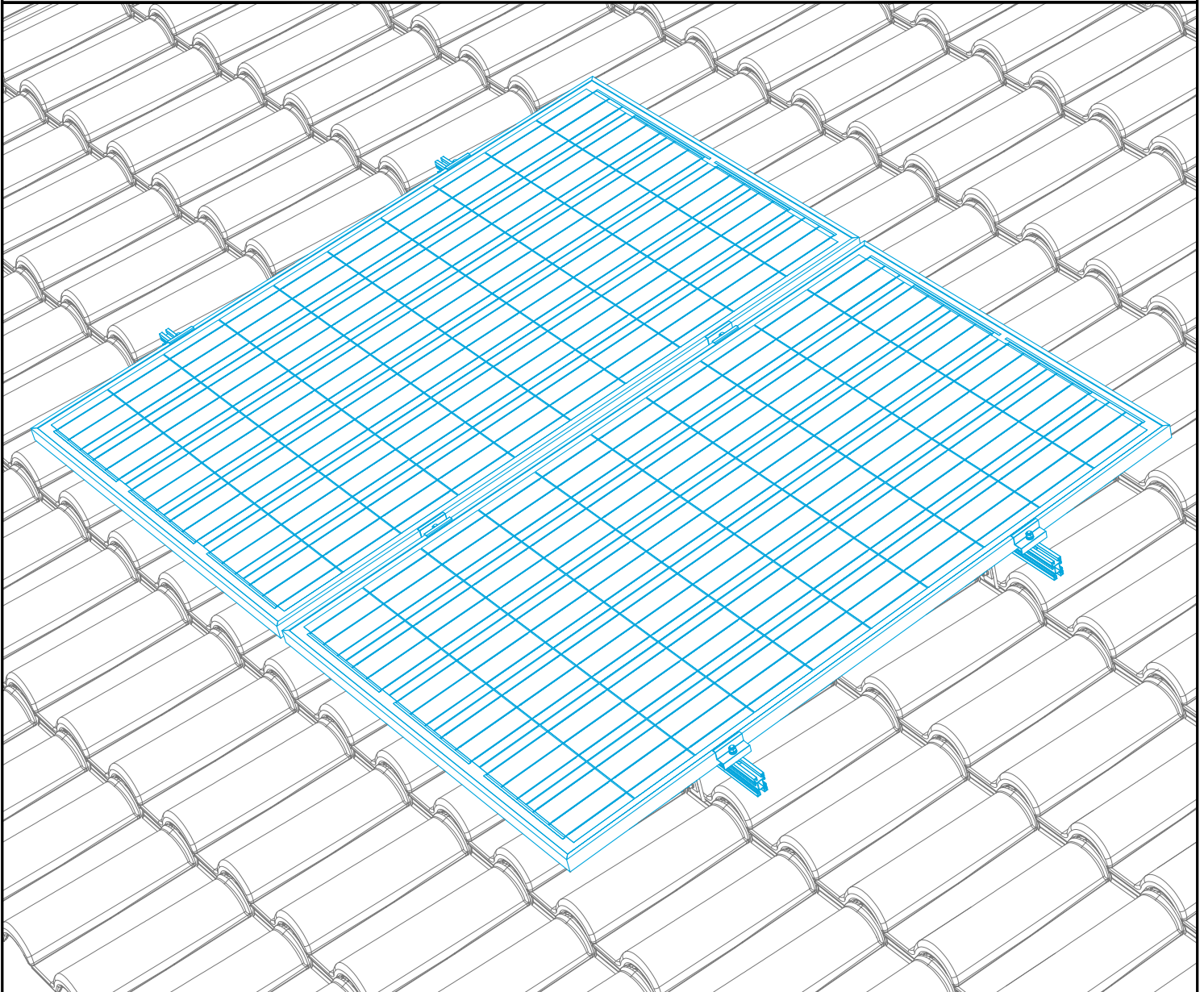







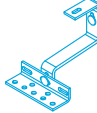

SUPLEMENTO KIT SOLAR EASY

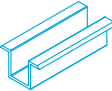
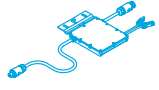
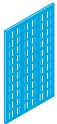
SOPORTE DE CUBIERTA
SOPORTE TELHADO

Manual de instalación
Manual de Instalação

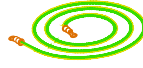

<p>1</p>  <p>x 4</p> <p>TORNILLO CABEZA DE MARTILLO M8X30 DIN186 INOX A2 PF CABEZA MARTELO M8X30 DIN186 INOX A2</p>	<p>2</p>  <p>x 2</p> <p>TORNILLO CABEZA DE MARTILLO M8X45 DIN186 INOX A2 PF CABEZA MARTELO M8X40 DIN186 INOX A2</p>	<p>3</p>  <p>x 4</p> <p>TORNILLO AUTO-TALADRANTE DE CABEZA CILINDRICA PHILIPS Ø3.5X13 DIN7504-N INOX A2 PF AUTO-PERFORANTE CQ PH Ø3.5X13 DIN7504-N INOX A2</p>	<p>4</p>  <p>x 6</p> <p>TUERCA HEXAGONAL M8 DIN934 INOX A2 PORCA M8 DIN934 INOX A2</p>	<p>5</p>  <p>x 4</p> <p>ARANDELA M8 DIN9021 INOX A2 ANILHA M8 DIN9021 INOX A2</p>	<p>6</p>  <p>x 6</p> <p>ARANDELA HELICOIDAL DE PRESION M8 DIN127 INOX A2 ANILHA MOLA M8 DIN127 INOX A2</p>	<p>7</p>  <p>x 2</p> <p>GANCHO INOX A2</p>	<p>8</p>  <p>x 2</p> <p>PERFIL ALUMINIO (LONGITUD 1100MM) PERFIL ALUMINIO (COMPRIMENTO 1100MM)</p>
<p>9</p>  <p>x 2</p> <p>FIXADOR ALUMINIO FIXADOR DE FECHO ALUMINIO</p>	<p>10</p>  <p>x 1</p> <p>MICRO INVERSOR</p>	<p>11</p>  <p>x 1</p> <p>MÓDULO PV</p>	<p>12</p>  <p>x 2</p> <p>TORNILLO CABEZA CILINDRICA HEX. INTERIOR M4X16 DIN912 INOX A2 PF CABEZA CILINDRICA SEXT INT M4X16 DIN912 INOX A2</p>	<p>13</p>  <p>x 2</p> <p>TUERCA HEXAGONAL M4 DIN934 INOX A2 PORCA M4 DIN934 INOX A2</p>	<p>14</p>  <p>x 3</p> <p>ARANDELA PLANA M4 DIN125 INOX A2 ANILHA M4 DIN125 INOX A2</p>	<p>15</p>  <p>x 1</p> <p>CABLE DE TIERRA 4MM (LONGITUD 870MM) CABO TERRA 4MM (COMPRIMENTO 870MM)</p>	<p>16</p>  <p>x 2</p> <p>CONECTOR PERFIL DE ALUMINIO (LONGITUD 300MM) CONECTOR PERFIL ALUMINIO (COMPRIMENTO 300MM)</p>

1 KIT DE DESCONEXIÓN DESCONEÇÃO DO KIT

Conector Micro Inversor / Cuadro o Toma eléctrica / Cable de tierra
Conector Micro Inversor / Quadro ou Tomada / Cabo terra

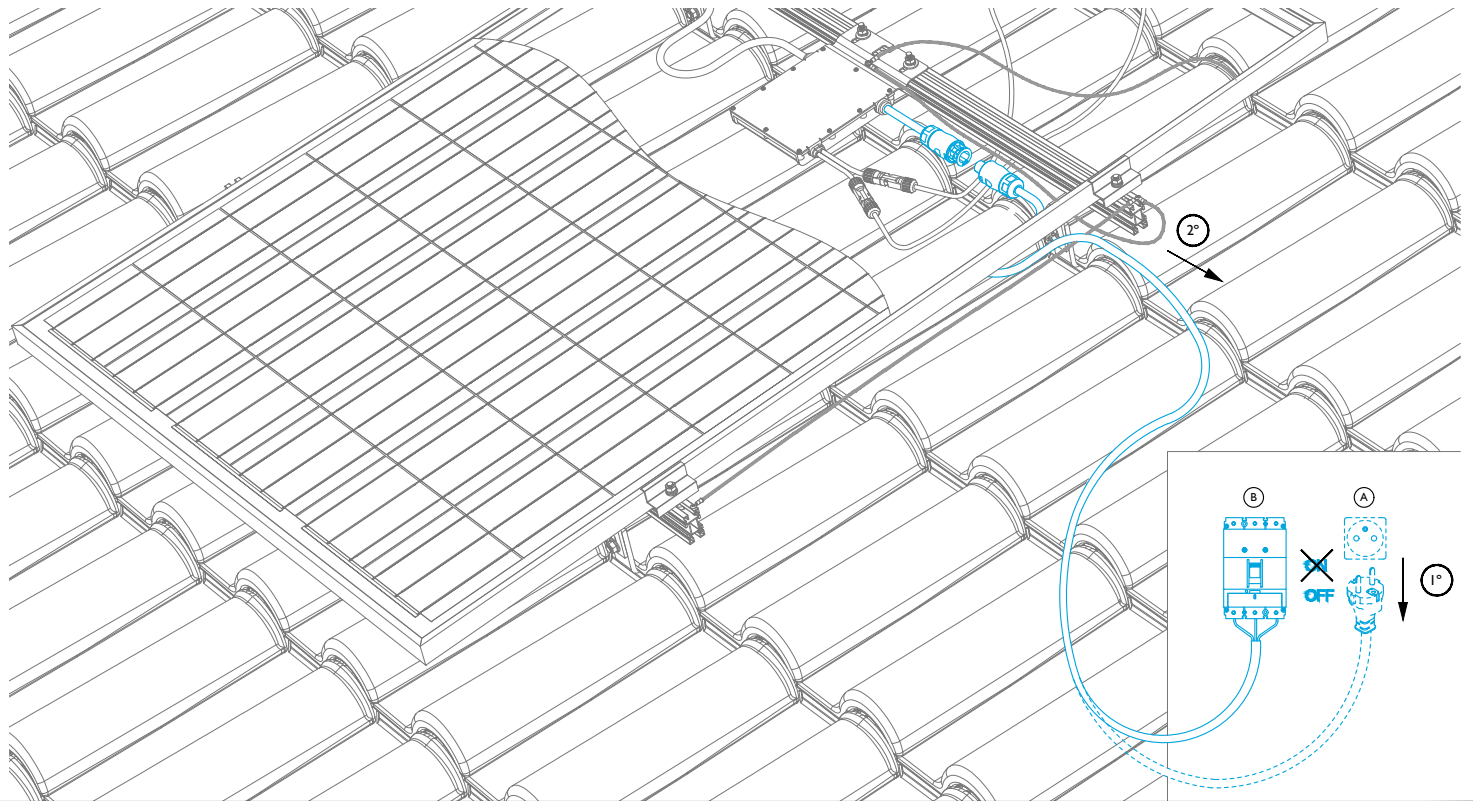

2 PERFORACIÓN Y FIJACIÓN DE LA ESTRUCTURA FURAÇÕES FIXAÇÃO ESTRUTURA

Perforar de acuerdo con sistema de fijación y tipos de tejas
Furações de acordo com sistema de fixação e tipo de telha

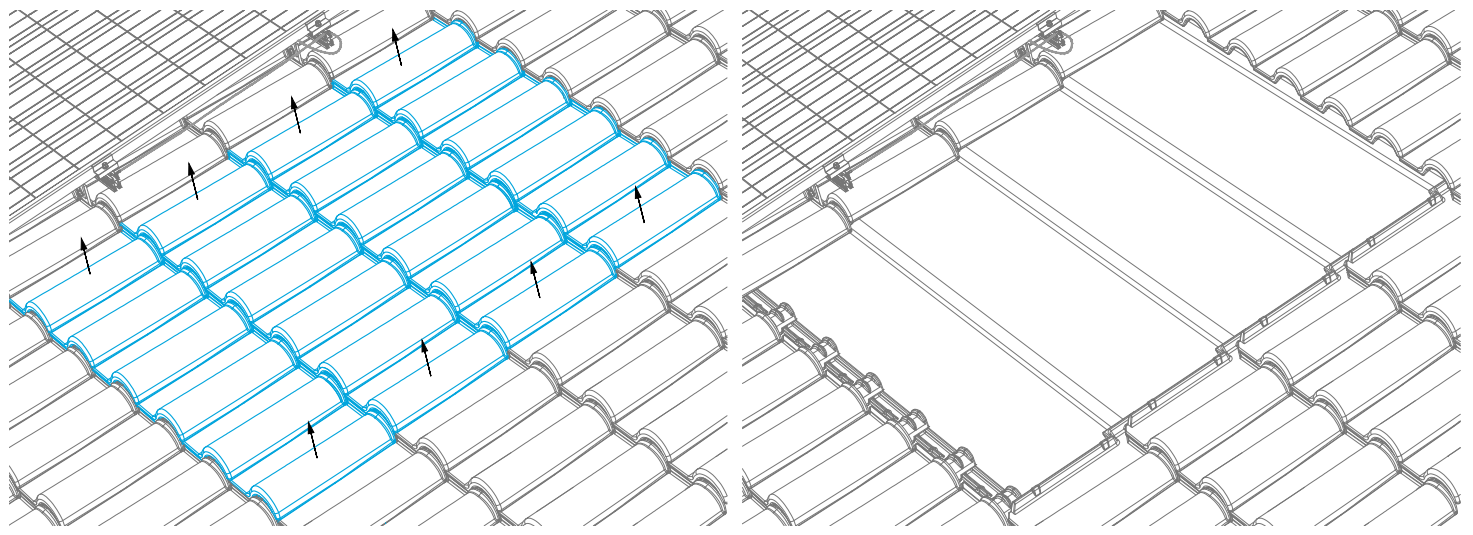



3 FIJACIÓN DE LOS GANCHOS EN INOX
 FIXAÇÃO GANHOS INOX
 Sistemas de fijación no incluídos
 Fixações não incluídas

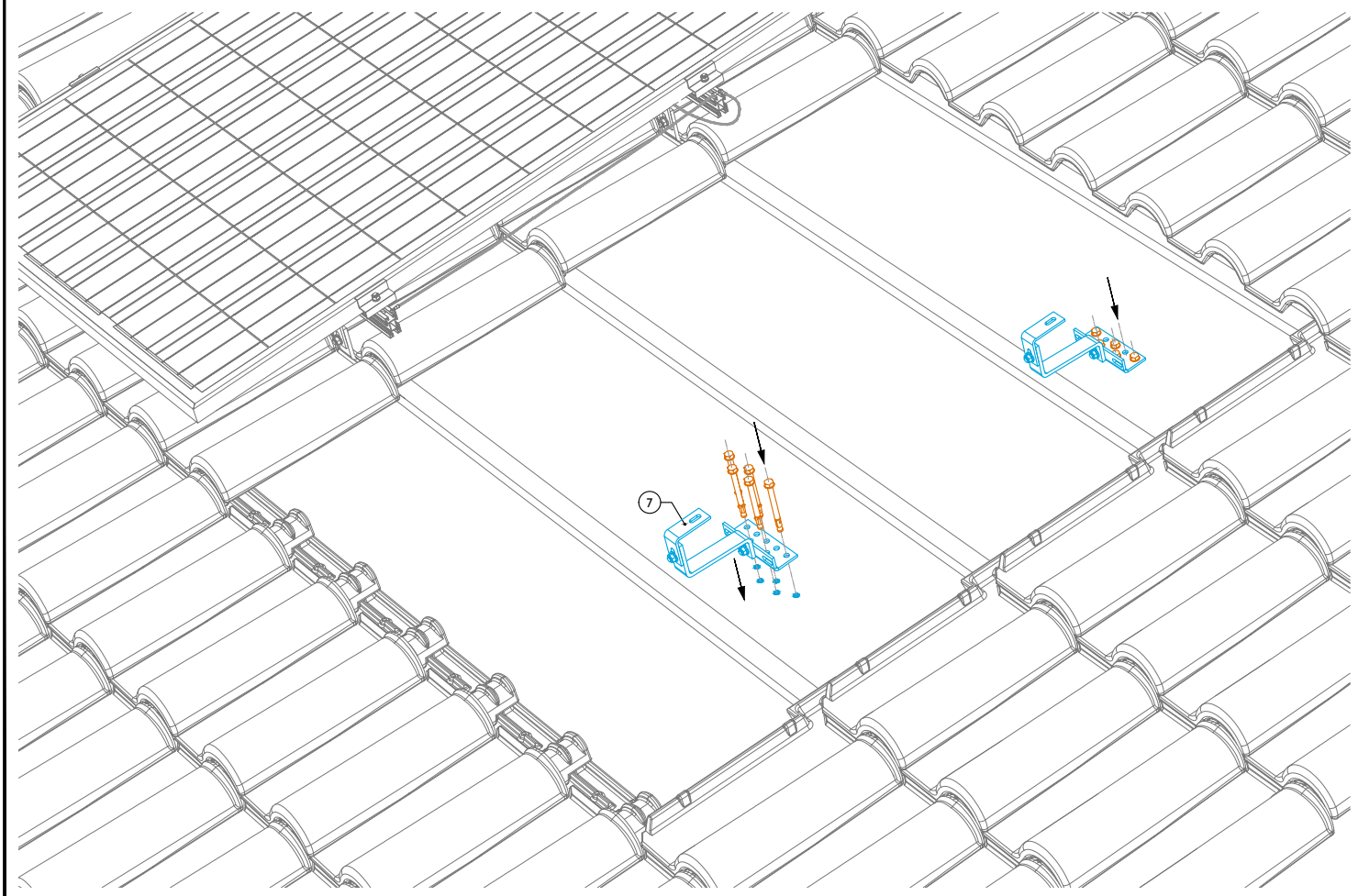

4 REPOSICIÓN TEJAS
REPOSIÇÃO TELHAS

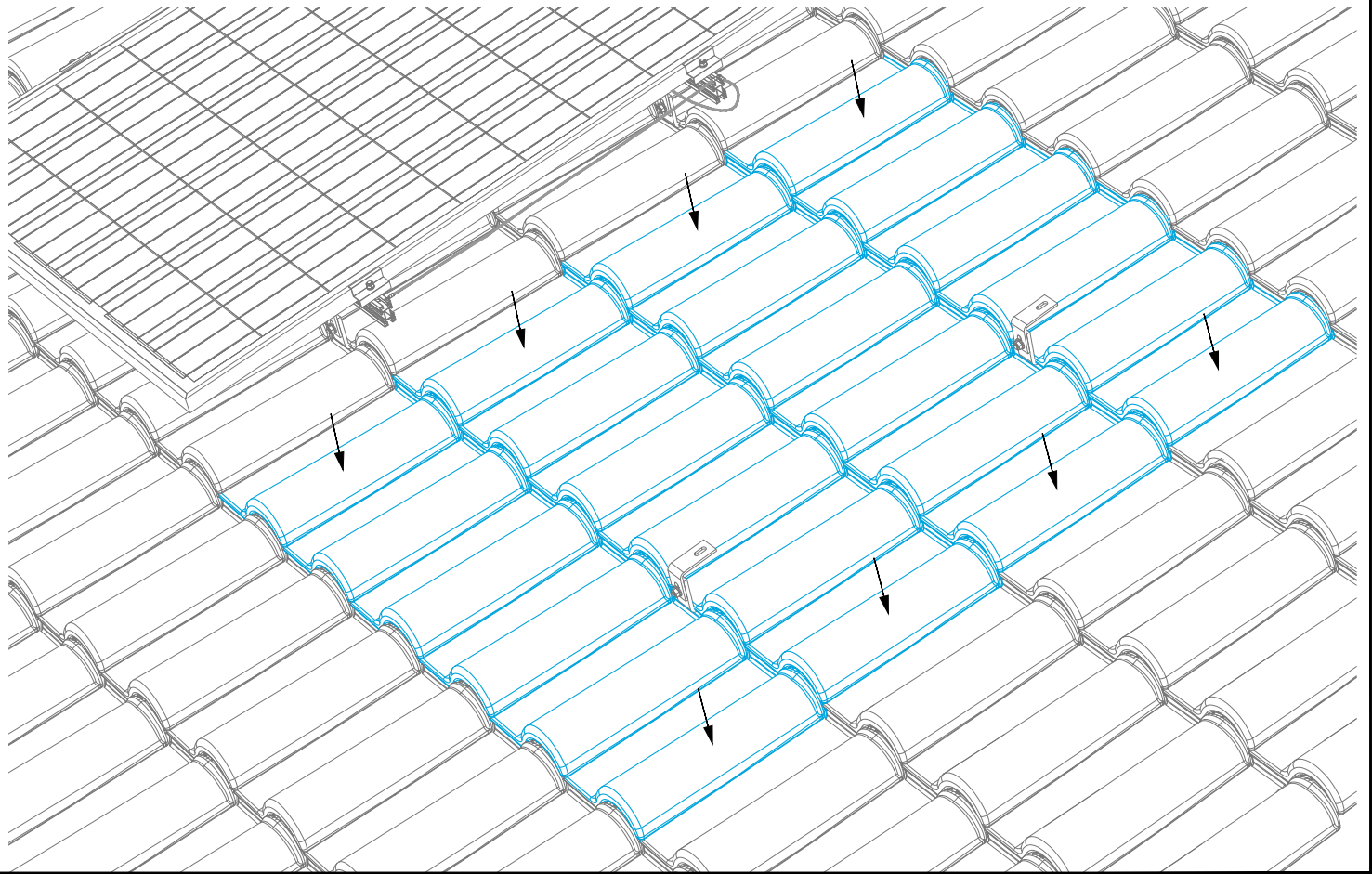

5 FIJACIÓN PERFILES ALUMINIO
FIXAÇÃO PERFIS ALUMÍNIO

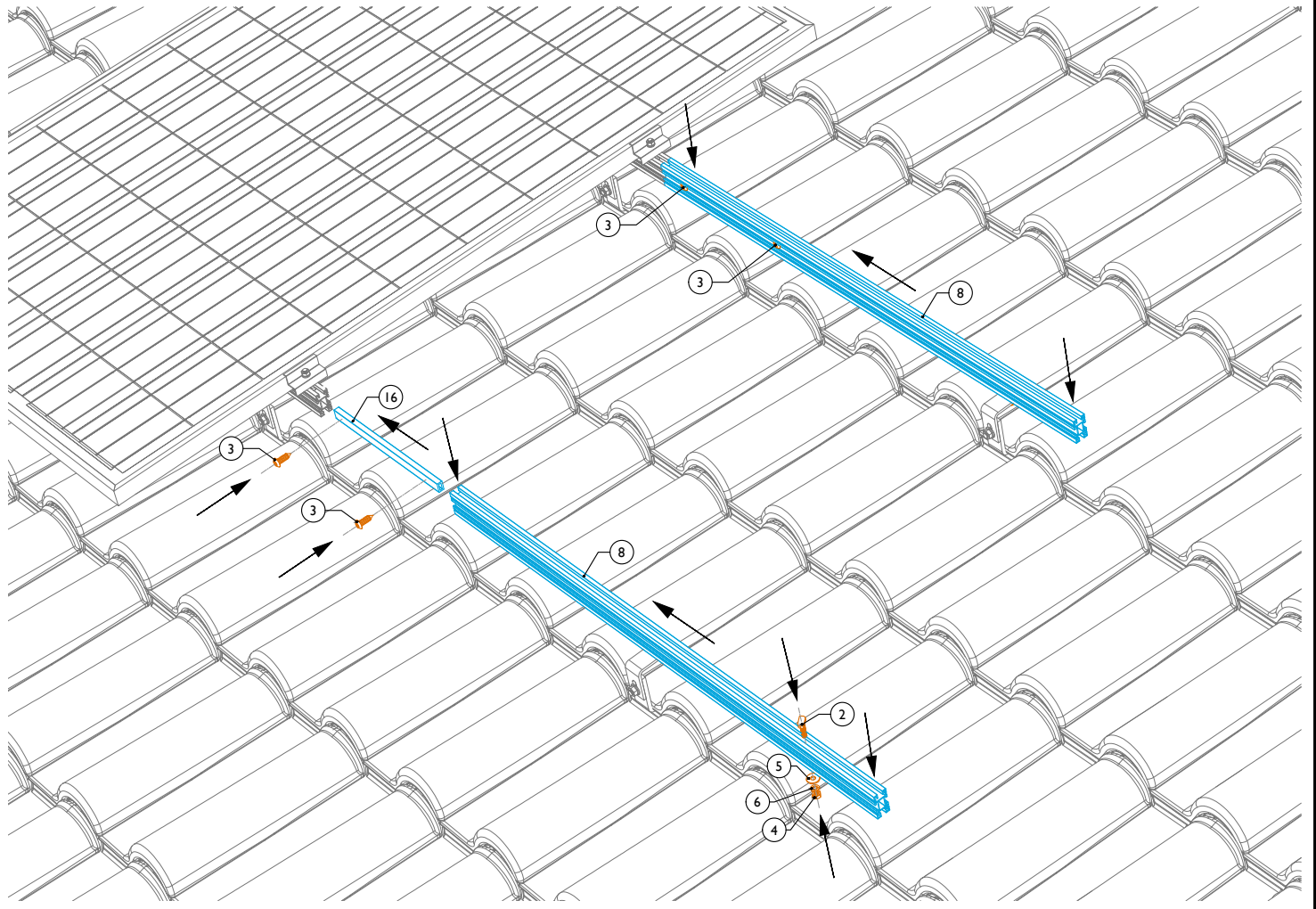

6 FIJACIÓN MICRO INVERSOR
FIXAÇÃO MICRO INVERSOR

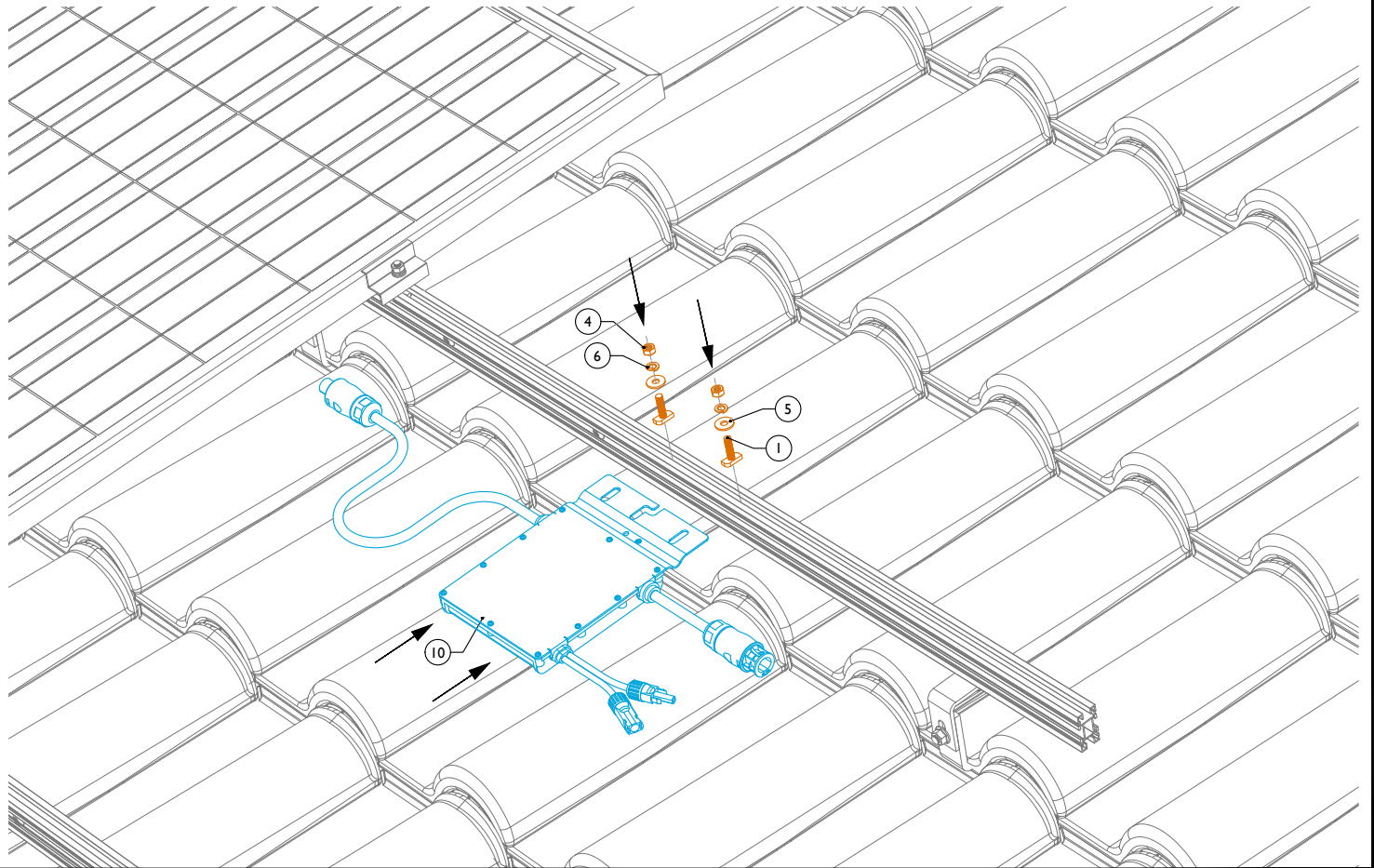

7 CONEXIÓN TIERRA DEL MICRO INVERSOR
LIGAÇÃO CABO TERRA AO MICRO INVERSOR

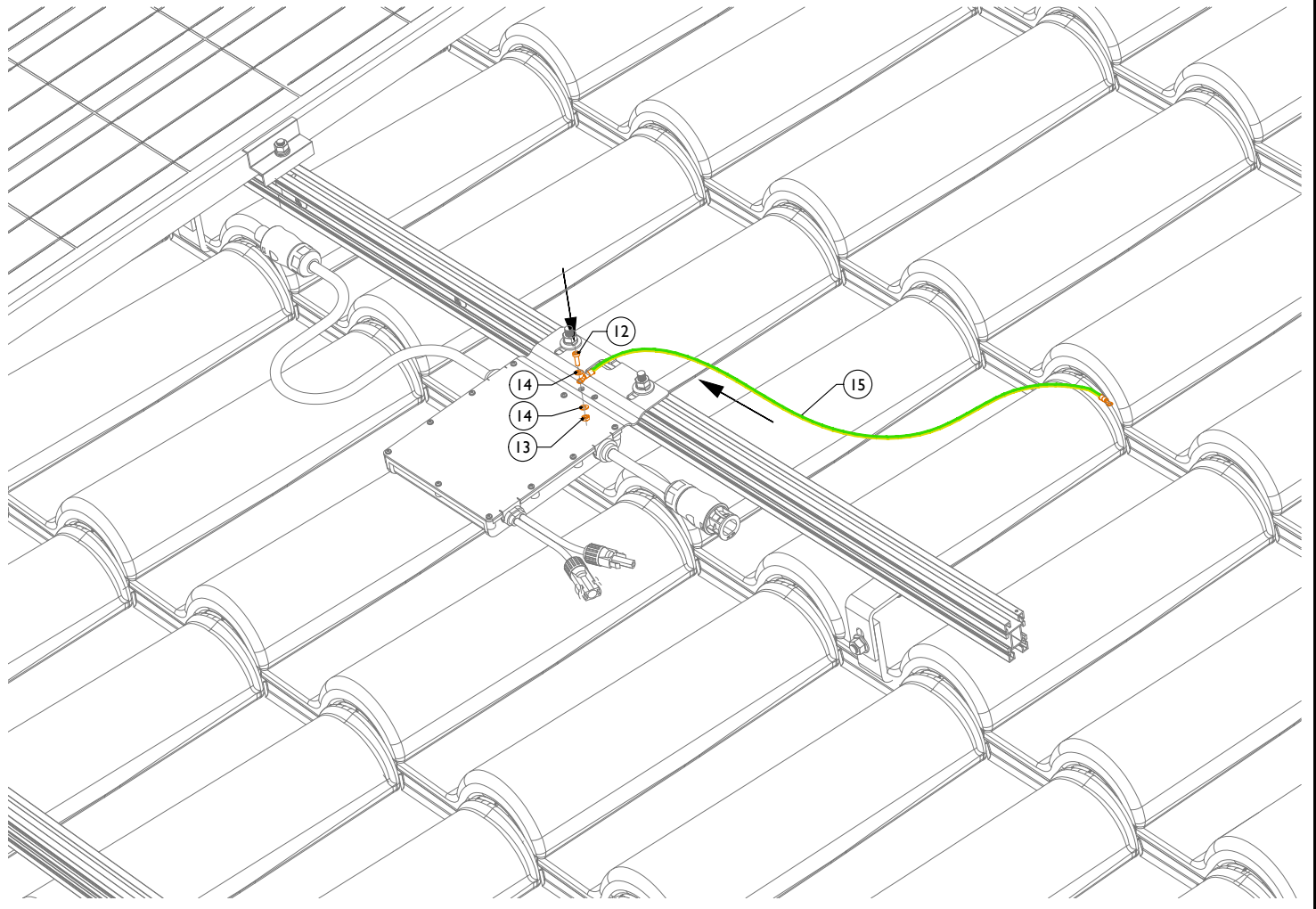

8 DESENROSCAR FIJADORES ALUMINIO
DESAPERTO FIXADORES DE FECHO

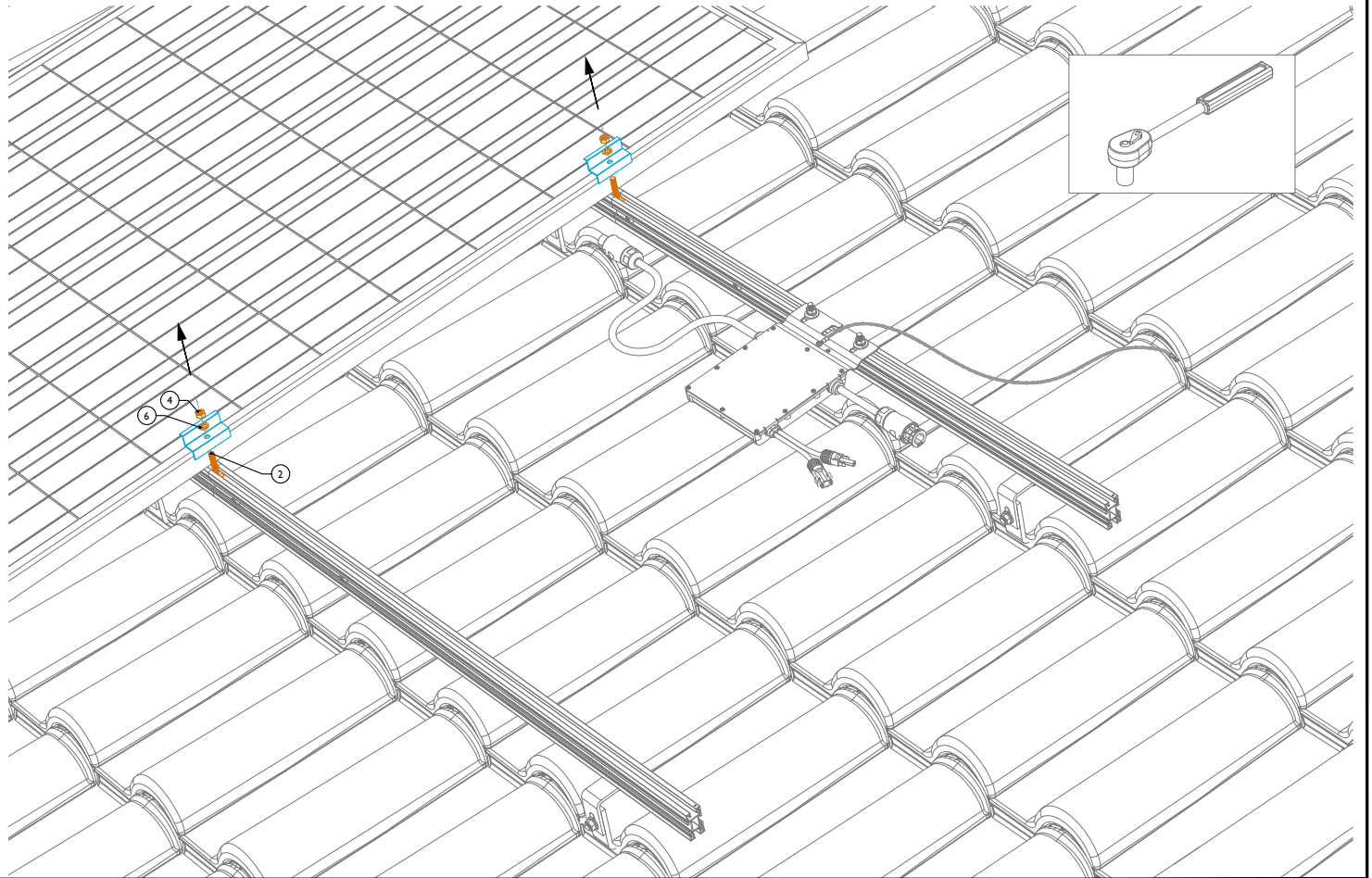

9 POSICIONAMIENTO FIJADORES EN ALUMINIO
POSICIONAMIENTO FIXADORES DE FECHO

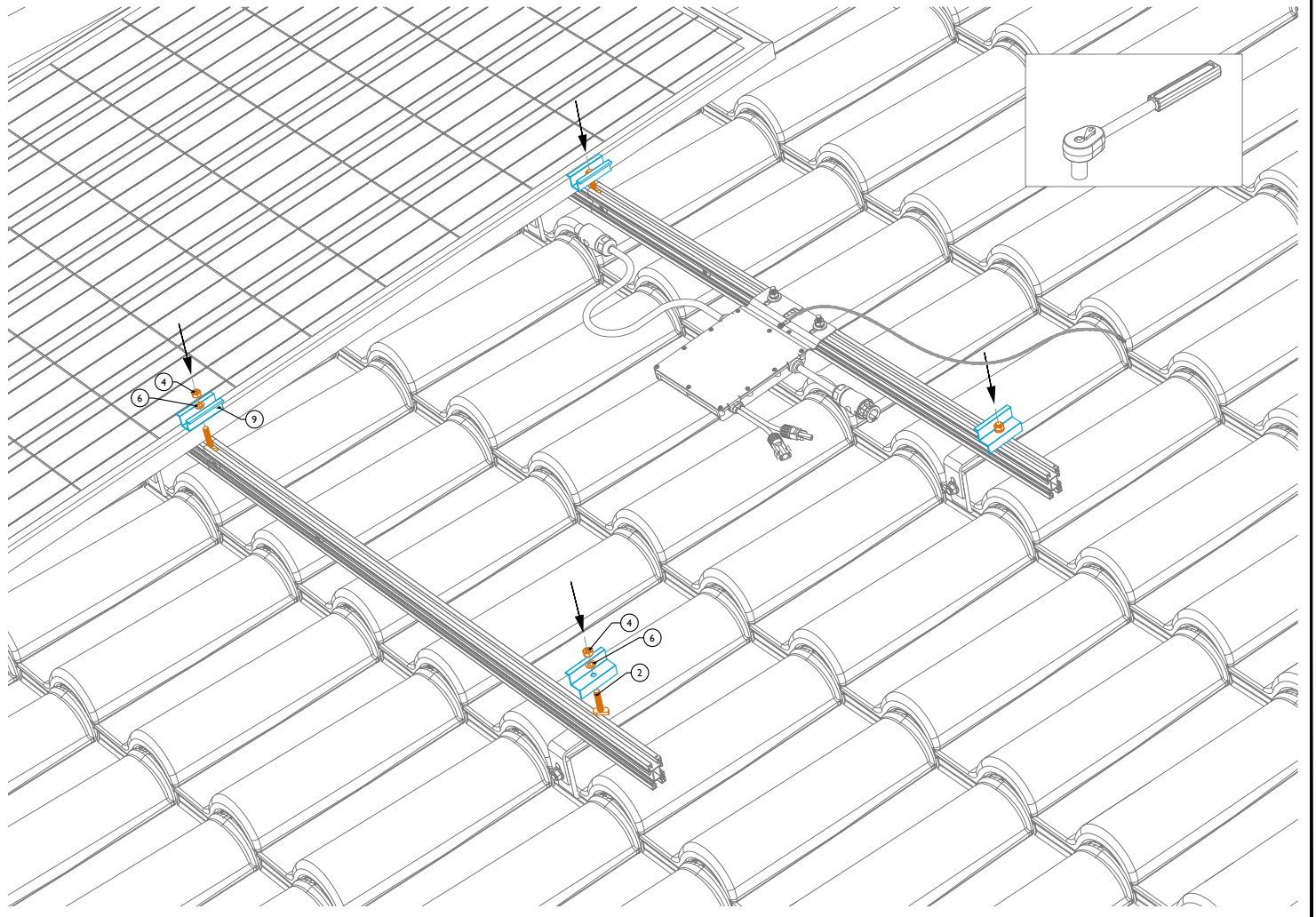

10 CONEXIÓN CA/CC Y TIERRA DEL MICRO INVERSOR
LIGAÇÕES AC/DC E TERRA DOS MÓDULOS

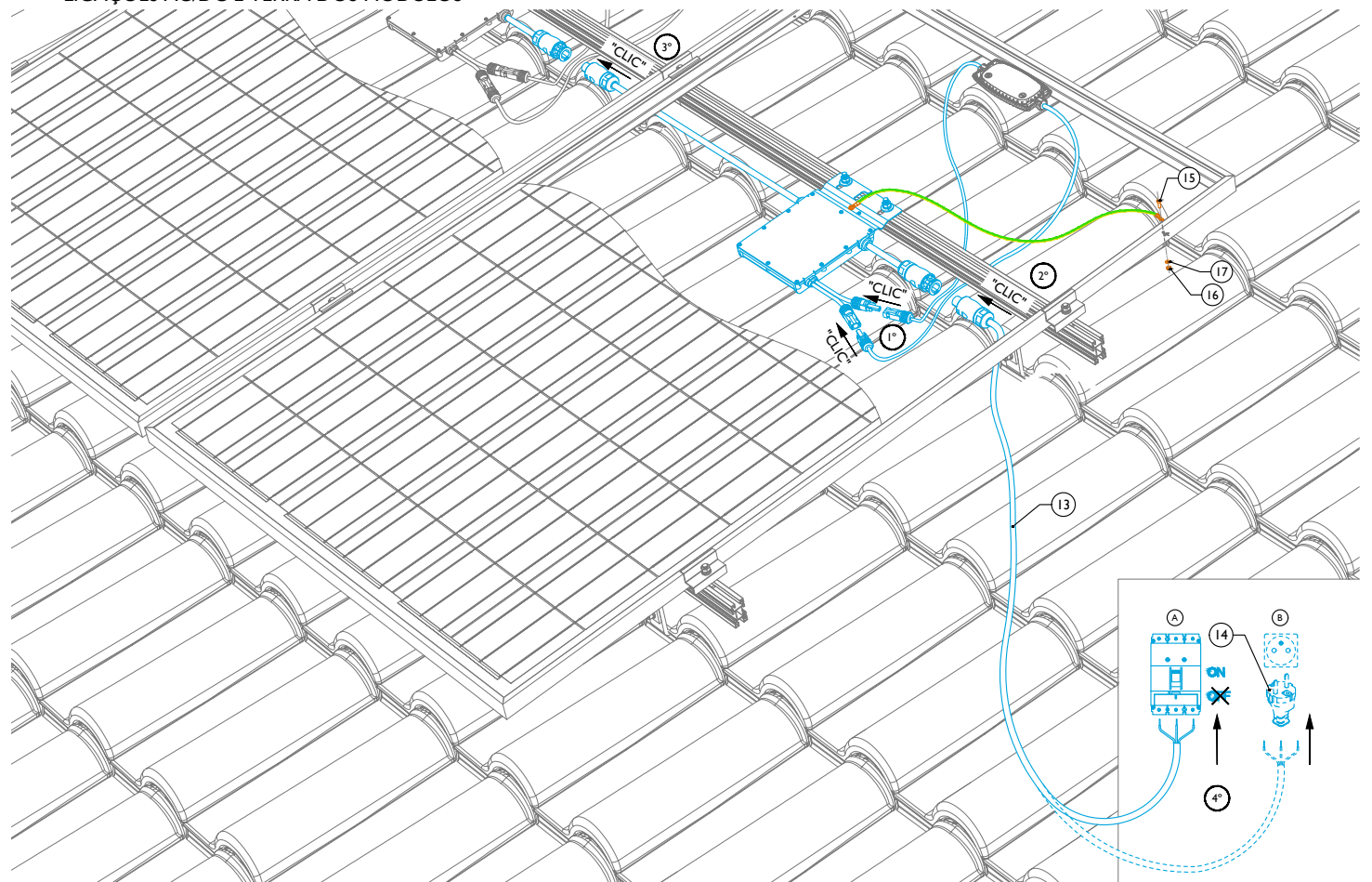

11 FIJACIÓN MÓDULO FV
FIXAÇÃO MÓDULO FV

